

Controlling Large-Scale Systems with Distributed Model Predictive Control

James B. Rawlings

Department of Chemical and Biological Engineering



November 8, 2010
Annual AIChE Meeting
Salt Lake City, UT

- 1 Overview of Distributed Model Predictive Control
 - Control of large-scale systems
- 2 Cooperative Control
 - Stability theory for cooperative MPC
- 3 Conclusions and Future Outlook
- 4 Some Comments on Tom Edgar

Model predictive control

What are the goals of MPC?

- Choose inputs which bring outputs to their setpoints
- Minimize objective function over N future steps

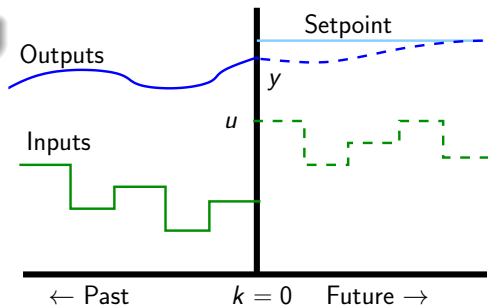

$$\min_{\mathbf{u}} V(x, \mathbf{u}) = \sum_{k=0}^{N-1} \ell(x(k), u(k)) + V_f(x(N))$$

subject to

$$x^+ = Ax + Bu$$

$$y = Cx$$

Chemical plant integration



Material flow

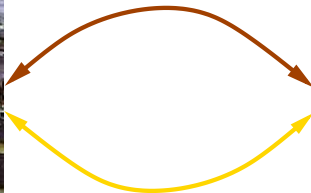

Energy flow



Ideal plantwide MPC

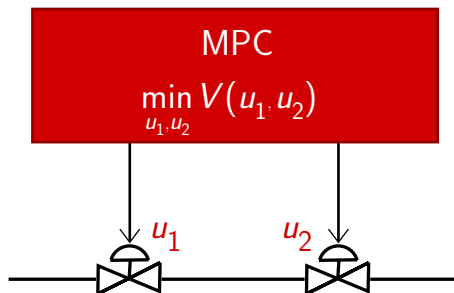

- Ideal controller
 - ▶ perfect model
 - ▶ never goes offline
 - ▶ optimizes infinitely fast
 - ▶ samples infinitely fast

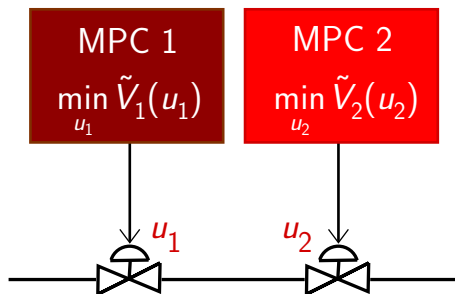

- Realistic controller
 - ▶ approximate model
 - ▶ MPCs fail or require maintenance
 - ▶ finite optimization time
 - ▶ multiple sampling rates
- **Goal:** make realistic controller close to ideal controller

Plantwide distributed MPC

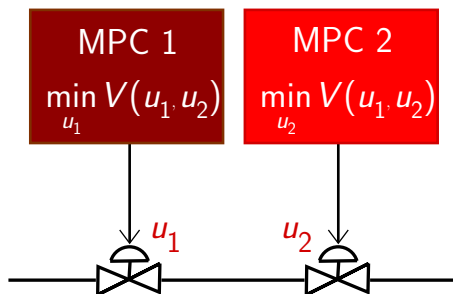

- Decentralized control
 - ▶ no communication
 - ▶ **not** stable for strongly interacting subsystems
- Noncooperative control
 - ▶ use full modeling information
 - ▶ **not** stable for strongly interacting subsystems
- Cooperative control
 - ▶ use same objective in each controller
 - ▶ stability independent of interaction strength

Cooperative model predictive control

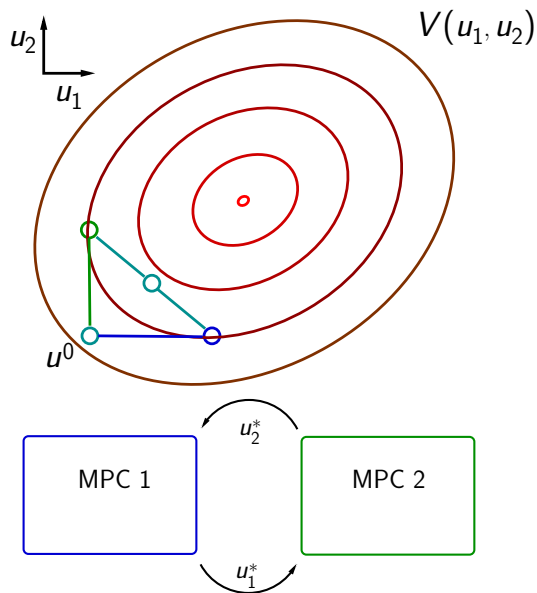

Plantwide suboptimal MPC

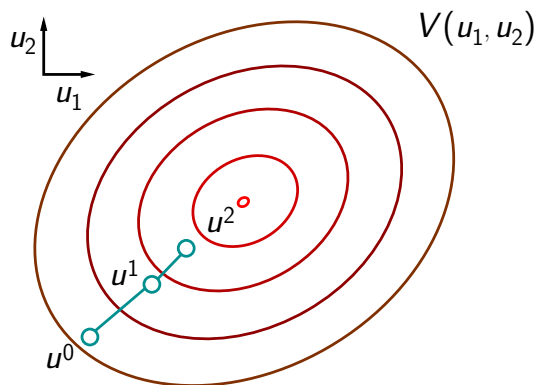

- Early termination of optimization gives suboptimal plantwide feedback
- Use suboptimal MPC theory to prove stability

Plantwide suboptimal MPC

Consider closed-loop system augmented with input trajectory

$$\begin{pmatrix} x^+ \\ \mathbf{u}^+ \end{pmatrix} = \begin{pmatrix} Ax + Bu \\ g(x, \mathbf{u}) \end{pmatrix}$$

- Function $g(\cdot)$ returns suboptimal choice
- Stability of augmented system is established by Lyapunov function

$$\begin{aligned} a \|(x, \mathbf{u})\|^2 &\leq V(x, \mathbf{u}) \leq b \|(x, \mathbf{u})\|^2 \\ V(x^+, \mathbf{u}^+) - V(x, \mathbf{u}) &\leq -c \|(x, \mathbf{u})\|^2 \end{aligned}$$

- Adding constraint establishes closed-loop stability of the origin for all \mathbf{u}^1

$$\|\mathbf{u}\| \leq d \|x\| \quad x \in \mathbb{B}_r, r > 0$$

- Cooperative optimization satisfies these properties for plantwide objective function $V(x, \mathbf{u})$

¹(Rawlings and Mayne, 2009, pp.418-420)

LV control of distillation column

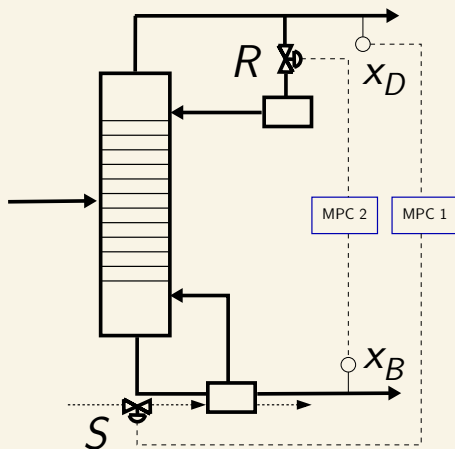

LV control of distillation column

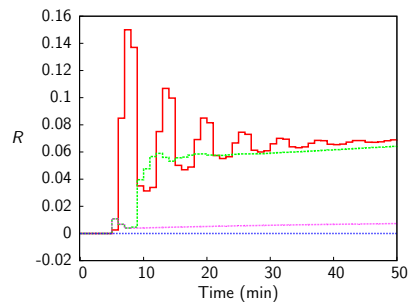
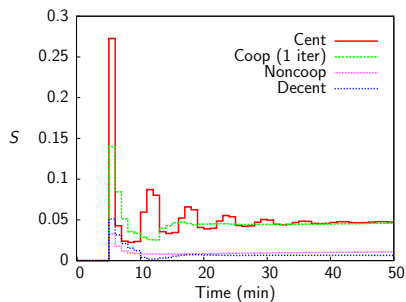
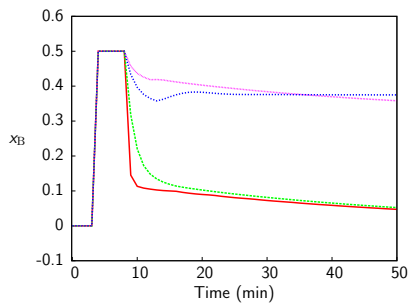
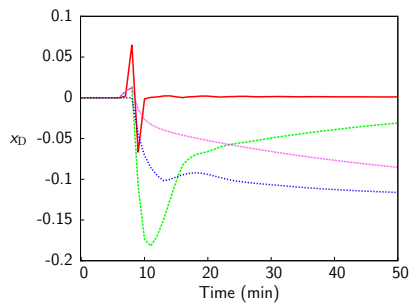

Performance comparison

	Cost	Performance loss (%)
Centralized MPC	75.8	0
Cooperative MPC (10 iterates)	76.1	0.388
Cooperative MPC (1 iterate)	87.5	15.4
Noncooperative MPC	382	404
Decentralized MPC	364	380

Plantwide topology

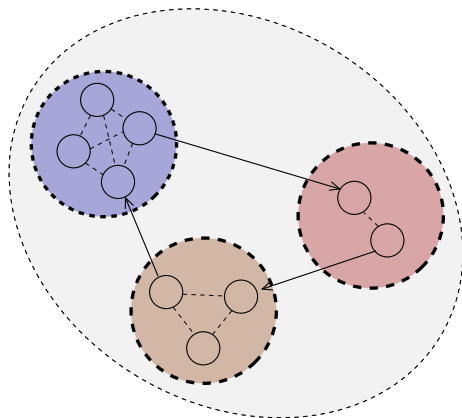

- Plant subsystems can often be grouped spatially or dynamically
- Neighborhoods of subsystems naturally arise from topology

Traditional hierarchical MPC²

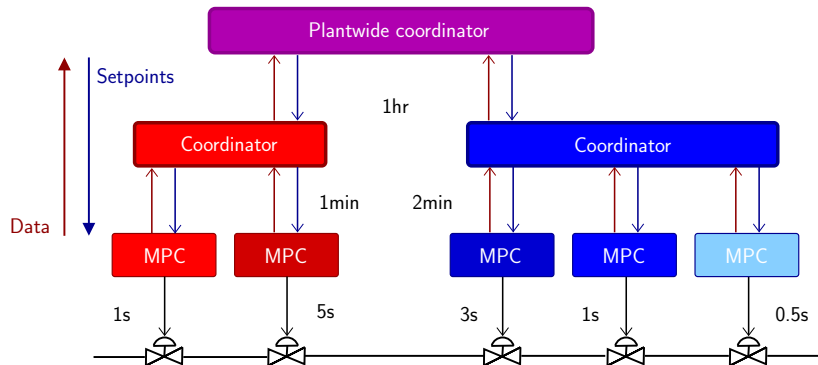

- Multiple dynamical time scales in plant
- Data and setpoints are exchanged on chosen scale
- Optimization performed at each layer

²Mesarović et al. (1970); Scattolini (2009)

Cooperative MPC data exchange³

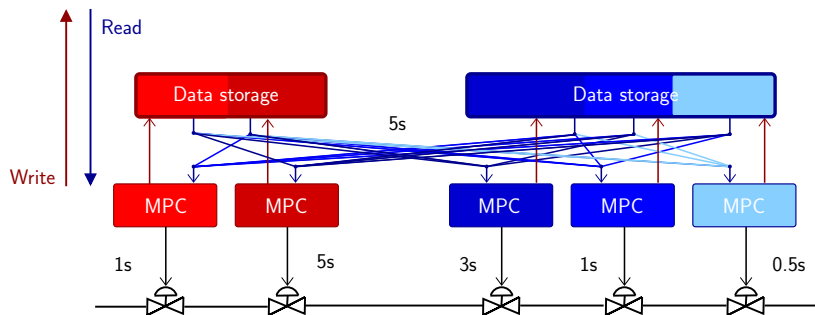

- All data exchanged plantwide
- Data exchange at each controller execution

³Venkat (2006); Stewart et al. (2010b)

Cooperative hierarchical MPC⁴

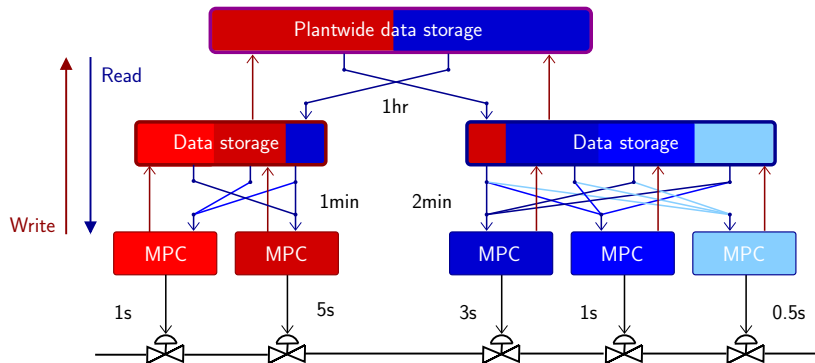

- Optimization at MPC layer only
- Only subset of data exchanged plantwide
- Data exchanged at chosen time scale

⁴Stewart et al. (2010a)

The challenge of nonlinear models

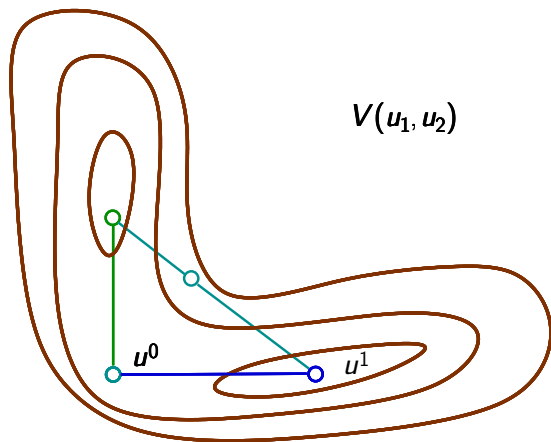

Distributed gradient projection - example

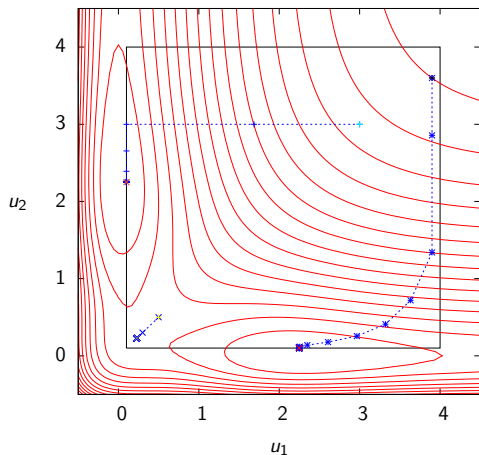

$$V(u_1, u_2) = e^{-2u_1} - 2e^{-u_1} + e^{-2u_2} - 2e^{-u_2} \\ + 1.1 \exp(-0.4((u_1 + 0.2)^2 + (u_2 + 0.2)^2))$$

Cooperative MPC theory maturing (Stewart et al., 2010b; Maestre et al., 2010)

- Satisfies hard input constraints
- Provides nominal stability for plants with even strongly interacting subsystems
- Retains closed-loop stability for early iteration termination
- Converges to Pareto optimal control in the limit of iteration
- Remains stable under perturbation from stable state estimator
- Avoids coordination layer

Extensions required for practical implementation

- Can we treat nonlinear plant models? Qualified yes.
- Can we avoid coupled constraints? Qualified yes.
- Can we reduce the assumed complete communication? Yes.
- Can we accommodate time-scale separation? Yes.
- Can we nest layers within layers? Yes.

Personal observations of Tom

- He's old

I took optimization from Tom when I was an **undergraduate!**

I did research with Tom when I was an **undergraduate!**

My **son** is now doing research with Tom as an **undergraduate!**

- He's wily

I've played a lot of golf with Tom over the years at research meetings, and I want to make it clear **he cheats!**

Tom was department chair when I joined the University of Texas as an assistant professor. He was a great mentor.

Tom founded the Texas Modeling and Control Consortium in 1993;

The Texas Wisconsin Modeling and Control Consortium in 1995;

The Texas Wisconsin California Control Consortium in 2007.

- He's a lot of fun to be around

Further reading I

- J. M. Maestre, D. Muñoz de la Peña, and E. F. Camacho. Distributed model predictive control based on a cooperative game. *Optimal Cont. Appl. Meth.*, In press, 2010.
- M. Mesarović, D. Macko, and Y. Takahara. *Theory of hierarchical, multilevel systems*. Academic Press, New York, 1970.
- J. B. Rawlings and D. Q. Mayne. *Model Predictive Control: Theory and Design*. Nob Hill Publishing, Madison, WI, 2009. 576 pages, ISBN 978-0-9759377-0-9.
- R. Scattolini. Architectures for distributed and hierarchical model predictive control - a review. *J. Proc. Cont.*, 19(5):723–731, May 2009. ISSN 0959-1524.
- B. T. Stewart, J. B. Rawlings, and S. J. Wright. Hierarchical cooperative distributed model predictive control. In *Proceedings of the American Control Conference*, Baltimore, Maryland, June 2010a.
- B. T. Stewart, A. N. Venkat, J. B. Rawlings, S. J. Wright, and G. Pannocchia. Cooperative distributed model predictive control. *Sys. Cont. Let.*, 59:460–469, 2010b.
- A. N. Venkat. *Distributed Model Predictive Control: Theory and Applications*. PhD thesis, University of Wisconsin–Madison, October 2006. URL <http://jbrwww.che.wisc.edu/theses/venkat.pdf>.